

Freshboost Blender

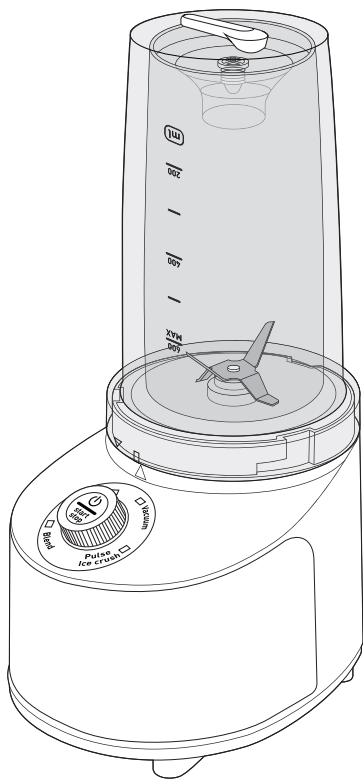

FR Lire attentivement le livret consignes de sécurité et ce livret avant la première utilisation.

EN Read safety instructions and booklet carefully before using for the first time.

DE Lesen Sie vor der ersten Benutzung die Sicherheitshinweise und die Broschüre sorgfältig durch.

NL Neem vóór het eerste gebruik dit boekje en het boekje met de veiligheidsvoorschriften aandachtig door.

IT Leggere con attenzione il libretto sulle norme di sicurezza e questo libretto, al primo utilizzo.

ES Lea detenidamente las instrucciones de seguridad y este folleto antes de utilizar el aparato por primera vez.

PT Leia atentamente as instruções de segurança bem como este folheto antes da primeira utilização.

EL Διαβάστε προσεκτικά το φυλλάδιο με τις οδηγίες ασφαλείας καθώς και αυτό το φυλλάδιο πριν χρησιμοποιήσετε τη συσκευή για πρώτη φορά.

DA Læs hæftet med sikkerhedsanvisninger og dette hæfte omhyggeligt, inden apparatet tages i brug første gang.

SV Läs häftet med säkerhetsinstruktioner och det här häftet noga innan du använder apparaten första gången.

FI Lue turvallisuuohjekirjanen ja tämä kirjanen huolellisesti ennen ensimmäistä käyttökertaa.

NO Les nøye heftet med sikkerhetsinstruksjoner og dette heftet før første gangs bruk.

TR Kullanmadan önce güvenlik talimatları kitapçığını ve bu kitapçığı dikkatlice okuyun.

RU Перед первым использованием прибора внимательно ознакомьтесь с правилами техники безопасности и данной инструкции.

UK Прочитайте інструкції з техніки безпеки і цю брошуру перед використанням уперше.

KK Бірінші рет қолданарда қауіпсіздік нұсқаулығын мұқият оқып шығыңыз.

RO Citiți cu atenție manualul cu instrucțiunile de siguranță și această broșură înainte de prima utilizare.

SL Pred prvo uporabo natančno preberite navodila za varno uporabo in ta navodila.

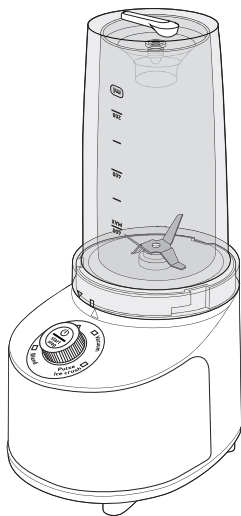

Pre prve upotrebe pažljivo pročitajte knjižicu s bezbednosnim uputstvima i ovu knjižicu.

SR

Molimo da prije prve uporabe pažljivo pročitate sigurnosne upute i upute za uporabu.

HR

Prije prve upotrebe pročitajte knjižicu sa sigurnosna uputstva i knjižicu o upotrebi.

BS

Прочетете внимателно книжката и съветите за безопасност в нея преди първата употреба.

BG

Lugege enne esimest kasutuskorda tähelepanelikult ohutusnõudeid ja seda brošüüri.

ET

Pirms pirmās lietošanas uzmanīgi izlasiet drošības norādījumus un šo informāciju.

LV

Prieš naudodami prietaisą pirmą kartą išdėmiai perskaitykite saugos instrukciją ir šią instrukciją.

LT

Przed pierwszym korzystaniem z urządzenia przeczytaj uważnie książkę z zasadami bezpieczeństwa oraz niniejszą instrukcję.

PL

Před prvním použitím si pozorně přečtěte brožuru s bezpečnostními pokyny a tuto brožuru.

CS

Pred prvým použitím si pozorne prečítajte brožúru „Bezpečnostné odporúčania a použitie“.

SK

Az első használat előtt figyelmesen olvassa el a biztonsági előírásokról szóló broszúrárt és a jelen broszúrárt.

HU

อ่านคำแนะนำเพื่อความปลอดภัยและคู่มือการใช้งานอย่างละเอียด ก่อนการใช้งานเป็นครั้งแรก

TH

처음 사용 전 안전지침과 현 책자를 잘 읽어 두시기 바랍니다.

KO

y oc số tay hướng dẫn an toàn v cu n số tay này trước khi sử dụng.

VI

使用前・請仔細閱讀安全建議手冊和說明書。

ZH

Sila baca buku arahan keselamatan dan buku ini sebelum penggunaan untuk kali pertama.

MS

اقرأ كتاب تعليمات الأمان بعناية قبل أول استخدام.

AR

قبل از استفاده، دفترچه راهنمای ایمنی و این دفترچه را مطالعه کنید.

FA





Selon modèle / Depending on model
Je nach Modell / Afhankelijk van het model
Secondo il modello / En función del modelo
Consoante o modelo / ανάλογα με το μοντέλο
Modelafhængig / Beroende på modell
Mallista riippuen / Avhengig av modell
Modele göre / в зависимости от модели
залежно від моделі / үлгіге байланысты
În funcție de model / Glede na model
Uzavisnosti od modela / Ovisno o modelu / Ovisno o modelu
В зависимости от модели / Soltuvalt mudelist
Atbilstoši modelim / Priklausomai nuo modelio
W zależności od modelu / Podle modelu
Podľa modelu / Modelltöl függően
แตกต่างกันไปในแต่ละรุ่น / 모델에 따라 다름
Tùy theo mẫu / 視乎型號而定
Bergantung pada model
بر حسب مدل / حسب الموديل

1

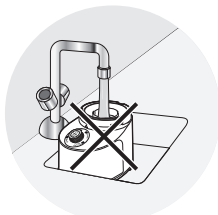

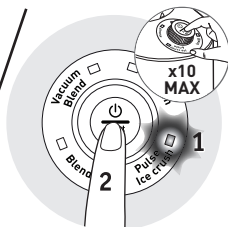
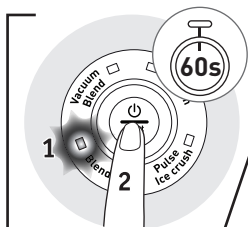
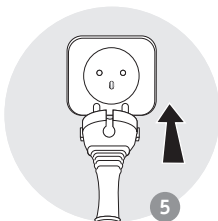
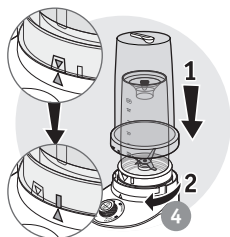
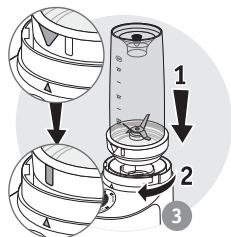
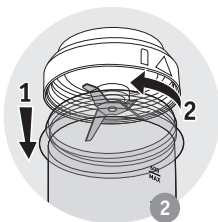

6

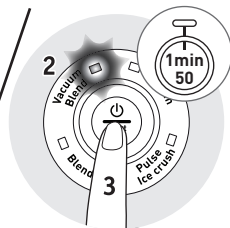
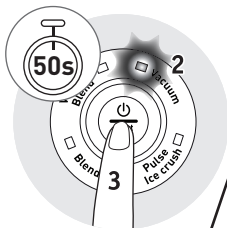
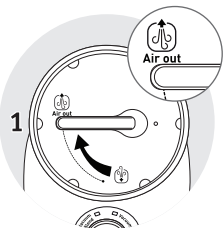



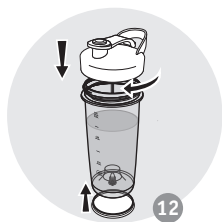
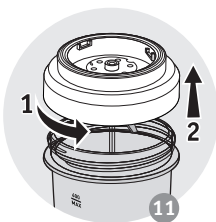
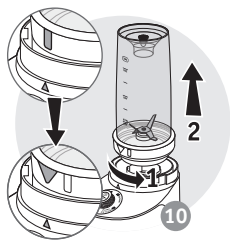
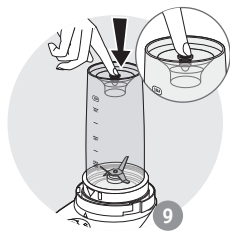
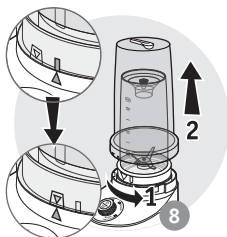
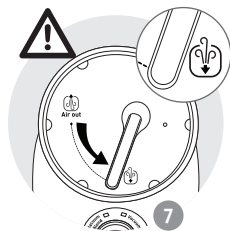



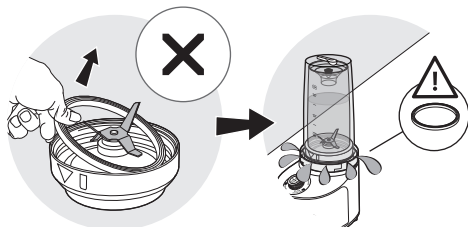
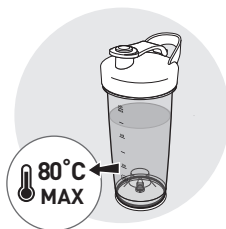
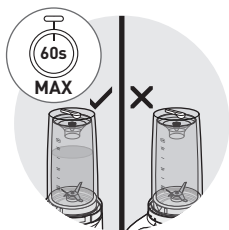
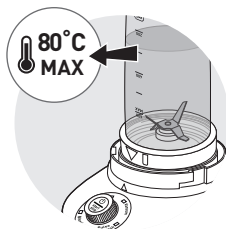
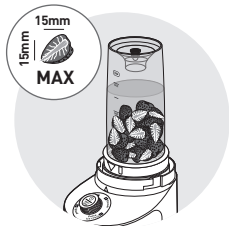



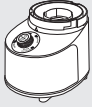





6



3

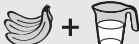

			
	✗	✗	✓
	✓	✓	✓
	✓	✓	✗
	✓	✗	✓

			
	 130 g 270 g	 Vacuum Blend	1min 50
	 130 g 270 g	 Vacuum Blend	1min 50
* 	 80 g	 Pulse	5 sec

